

DURO-FRANCE

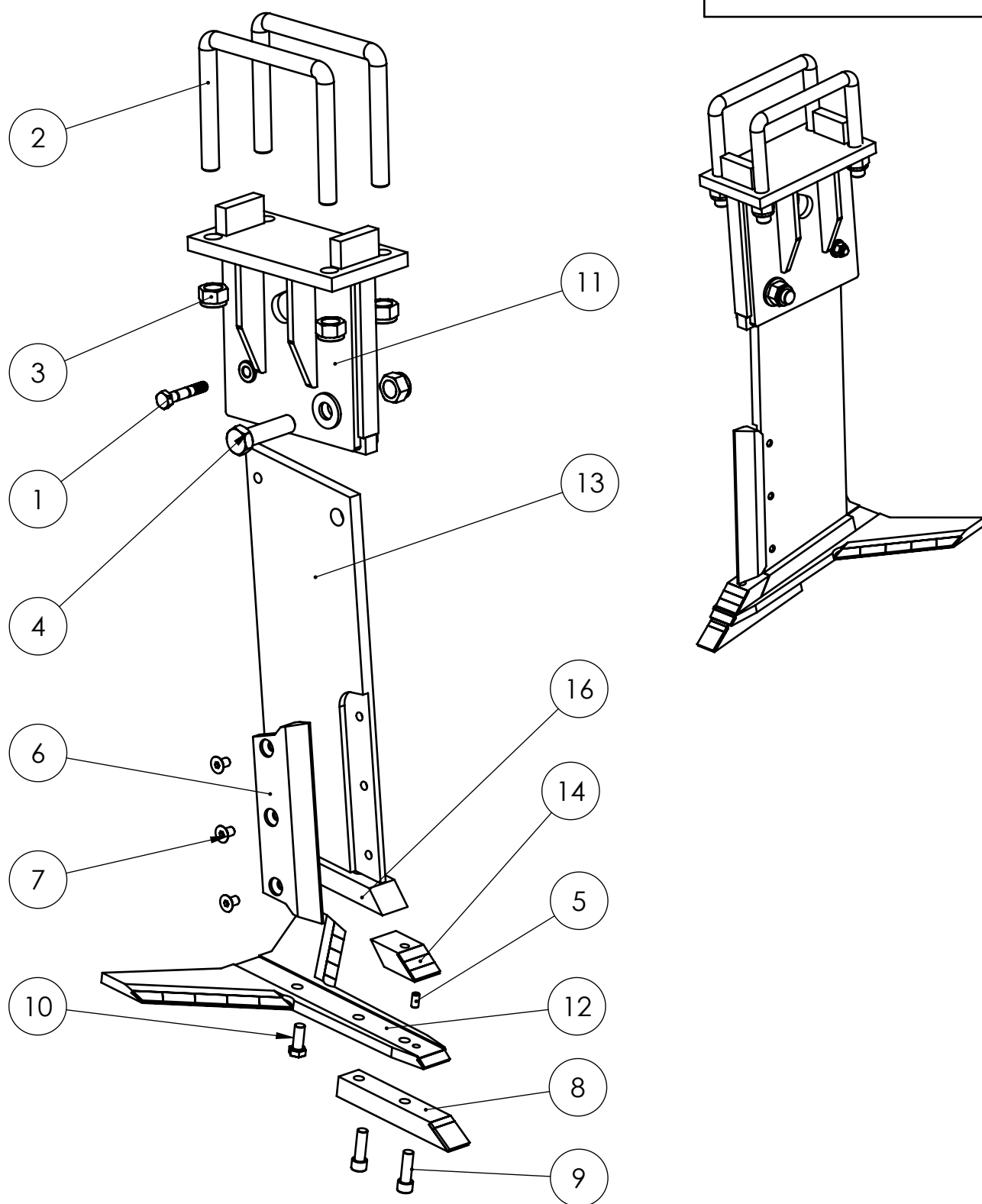

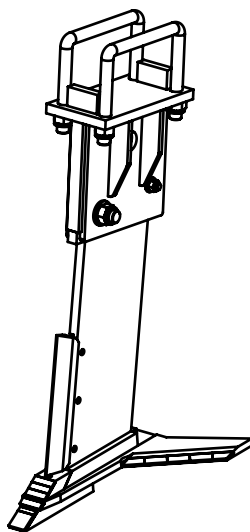



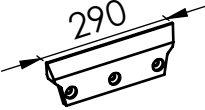
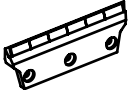

dent sécurité boulon
Référence Pièces : dent-1009-c

Poids : 57.51 Kgrs

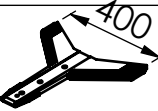
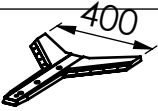

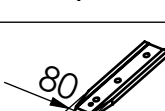
Poids : 57.51 Kgrs

N°	Réf. magasin	Designation	Qté
1	0100368	boulon sécurité décompacteur	1
2	007738	bride support étau décompacteur	2
3	008319	Ecrou H bague nylon M 24	5
4	014986	vis articulation étau	1
5	008461	Goupille élastique D10 x 20	1
6	voir tableau pièces usures	protège étau	1
7	008569	Vis TFHC M12 x 20	3
8	voir tableau pièces usures	pointe	1
9	008687	Vis CHC M14 x 45	2
10	008685	Vis TH M 14 x 35 x 1.50	1
11	004029	support étau	1
12	voir tableau pièces usures	soc	1
13	004044 (droite) / 004045 (gauche)	étau	1
14	voir tableau pièces usures	Nez démontable	1

repère N°	Réf. magasin	Désignation	
6	004031	Protège étançon	
	004121	Protège étançon carbure	
14	DENT-1033	Nez démontable tout carbure	
12	DENT-0067	Soc Jallu 400 mm	
	DENT-0072	Soc Jallu 400 mm avec rechargement	
	DENT-1032	Soc Jallu 400 mm carbure	
	DENT-0073	Soc Jallu 260 mm avec rechargement	
	DENT-1035	Soc Jallu 260 Carbure	
	DENT-0074	Soc sous soleuse	
8	dent0048	Pointe carbure 30 x 30	
	dent0049	Pointe carbure 40 x 30	
	dent0069	Pointe carbure 60 x 30	
16	004120	Sabot d' accrochage (à souder)	